



CATALOG / 24

- Special and Standard Type Freight Wagons,
- Special and Standard Type Bogies,
- Railway Machineries and Components,
- Locomotive Components,
- Steel Structure Components,

www.esray.com.tr



ESRAY A.Ş. has been producing special and standard types of freight wagons and bogies for the railway sector since 1992. The company has the necessary certificates, knowledge and references for the production of chassis and cabins for special construction machines and locomotives. ESRAY also has international certificates that can maintainance freight wagons Special Construction Machinery, Locomotives, passenger carriages and high speed OTMs.

For more detailed information, please contact our teams



◀ You can review our digital catalog
for up-to-date and more detailed content.

ES RAY
Design and Production of Railway Industry

www.esray.com.tr





Special Type Wagon Production

Ballast Machinery with Crane



◀ Opportunity to work at night with lighting system

Slab Transport Wagon



▲ 150 Ton Carrying Capacity
Coil Transport at 800 C°

Slab & Coil Transport Wagon



▲ 150 Ton Carrying Capacity
Roll and Slab Transport at 800 C°

complete manufacturing according to the project

Multi-Purpose Product Carrying Wagon



Ladle Carrier Wagon



Standard Type Wagon Production

Ballast Wagon



”

FACCPSS WAGON,
with large transport
volume, ballast pouring
for a longer distance at
once

40",45", 60",80",90" Container Wagons



Sgss Light Type
Container Wagon

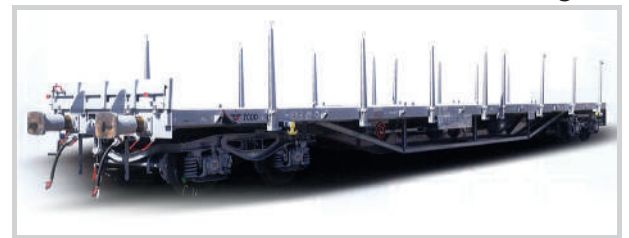

Rilns Wagon



Eanoss Wagon



Rgs Wagon

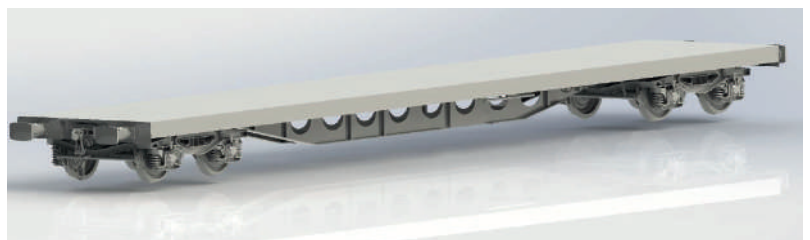

Special Type Bogie Production

3 Axle Bogie

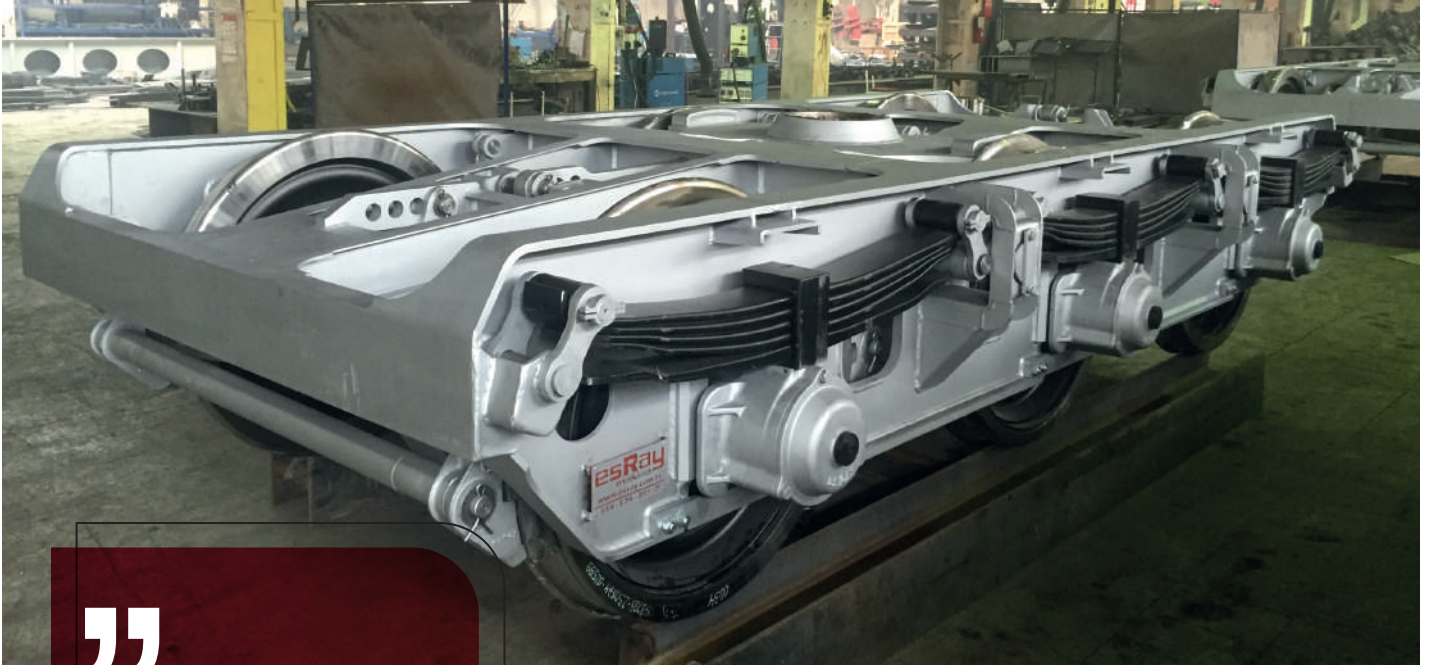

”

75TON
capacity

Rail Spacing	: 1435 mm
Wheel Diameter	: 920
Maximum Service Speed	: 50 Km/H
Suspension	: 6 Leaf Suspension
Axle Diameter	: 180
Axle Load	: 25 t
Brake system	: 12 Adet 3201 Pik Sabo
Number of Axles	: 3
Axles Axis Distance	: 1500 mm
Primary and Secondary	: 1200 mm
Suspension Axis Distance	

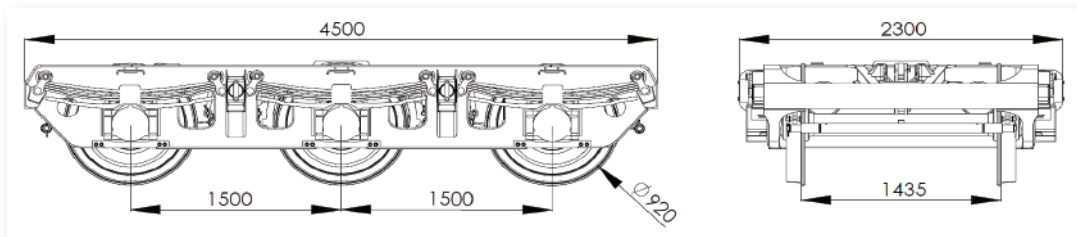

Standard Type Bogie Production

Y-25 Bogie Family with TSI Certified



H-Type Bogie with
Classical Brake System

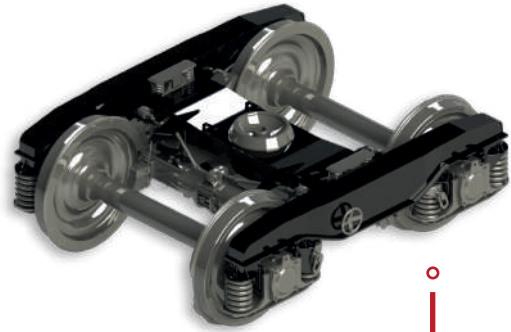

H-Type Bogie with
Knorr Brake System

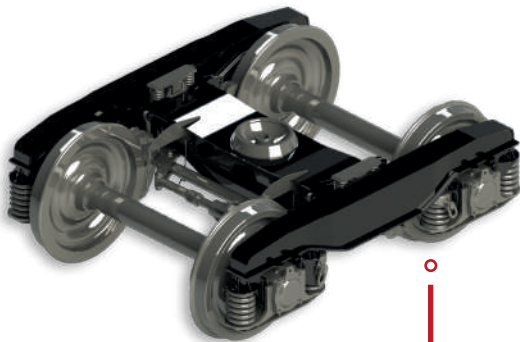

H-Type Bogie with
Wabtec Brake System



Y-25LSD1 with
Classical Brake System

Chassis Production



Uacns & Zacens Tank Wagon Chassis

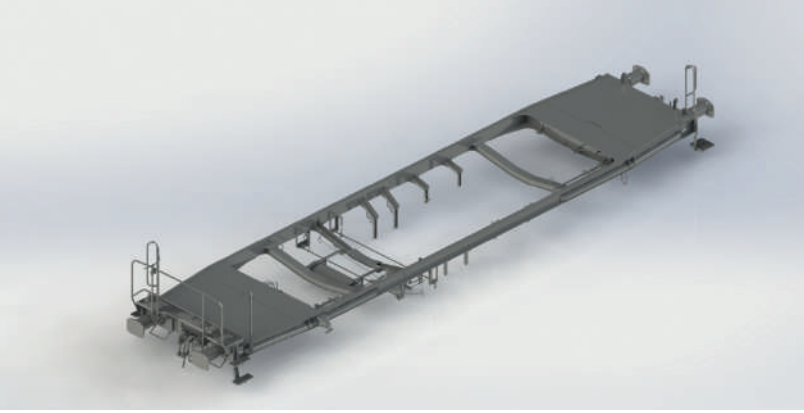

Roller Wagon Chassis

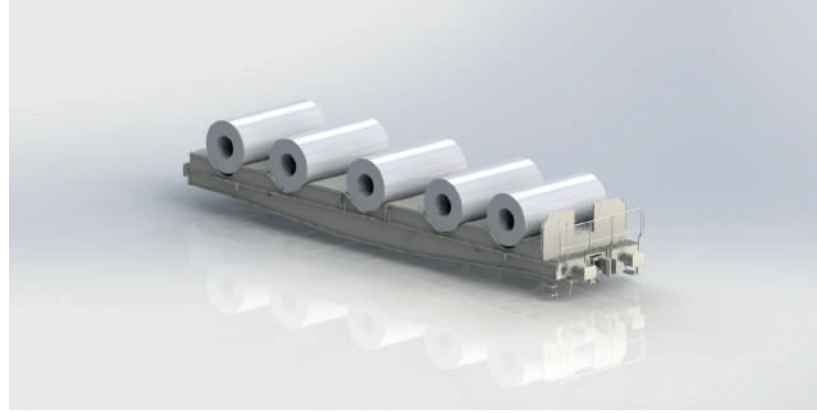

Multipurpose Vehicle Chassis



Manufacturing special designed products with requested standards

Locomotive Chassis

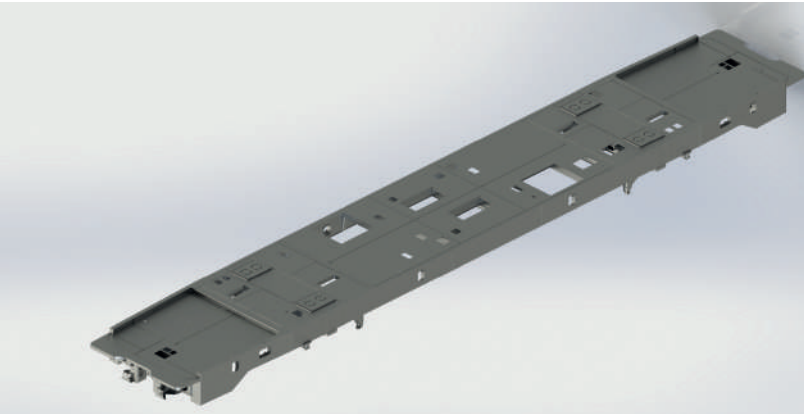

Special Trailer's Chassis

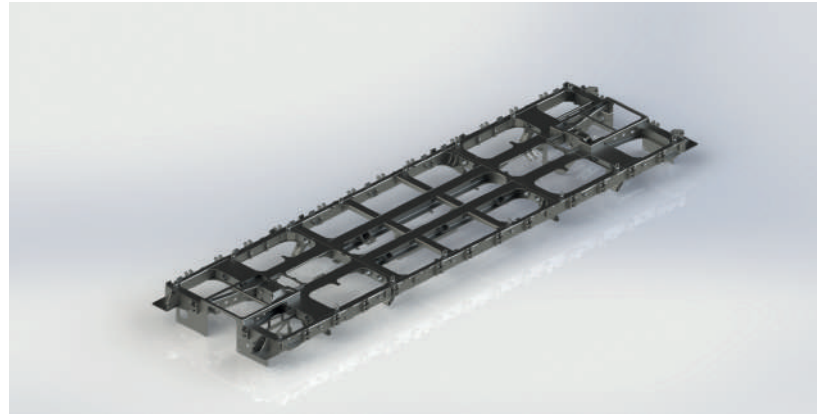

Locomotive Marquises

Cabinet production in various material thicknesses and qualities

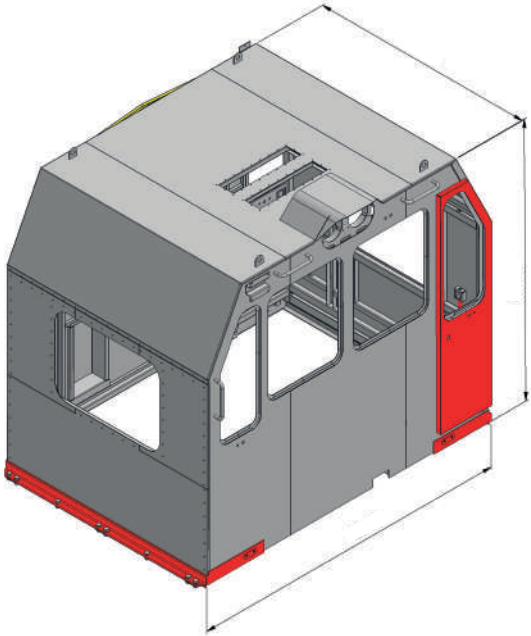

Locomotive Structure



Locomotive Cabins

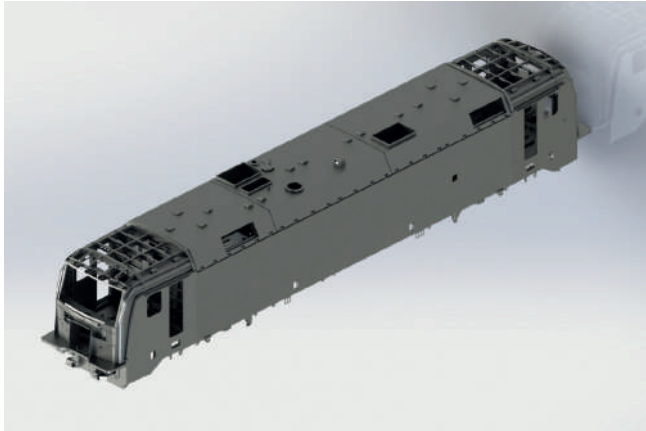

Personnel Transport Cabins

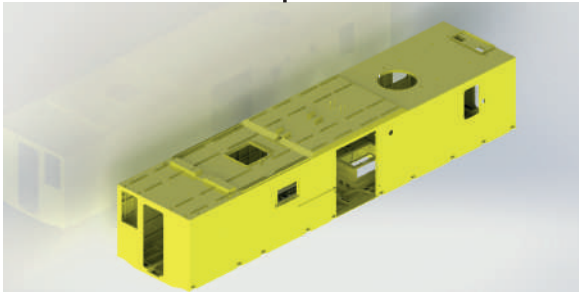

Driver Cabins



Machine Room Cabins

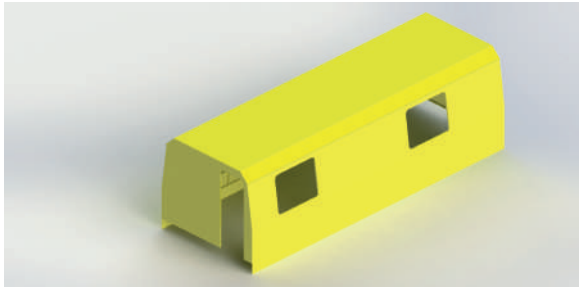

Component Production



■ Ballast Transport Container



■ Sensor Side Beam

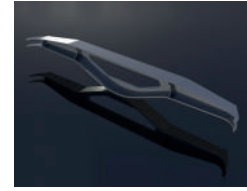

■ Side Beam Sensorless

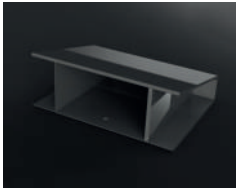

■ Wagon Towing Hook Support



■ Retainer Arm

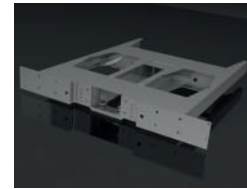

■ Sgs Wagon Bumper Traverse

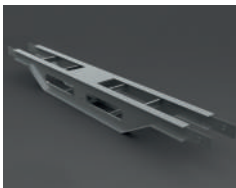

■ Connection Beam Right



■ Müselles



■ Container Bed Support

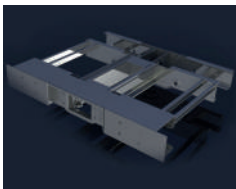

■ Container Wagon Bumper Traverse

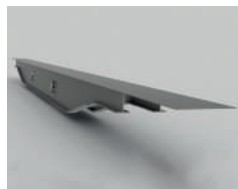

■ Container Wagon Length Beam



■ Container Holder Slot



■ Container Holder Slot (Double)



■ Suport



■ Brake Drawbar



■ Brake Pull Frame

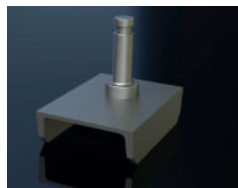

■ Direk Suportu

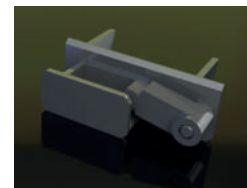

■ Mast Fixing Right



■ Mast Assembly



■ Bogie Middle Traverse



■ Connection Beam Right

EN 15085 - 2



ISO 9001 : 2015

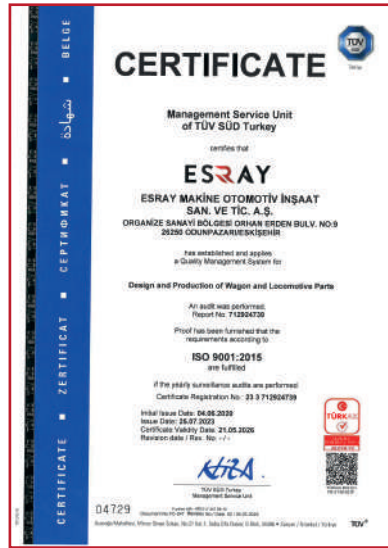

ISO 14001 : 2015

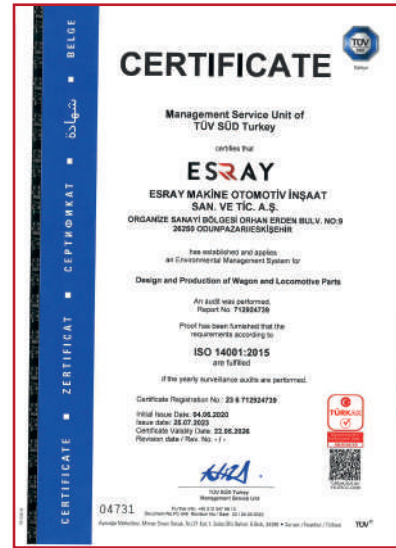

ISO 45001 : 2018



TS EN ISO 3834 - 2



Entity in Charge of Maintenance(ECM)

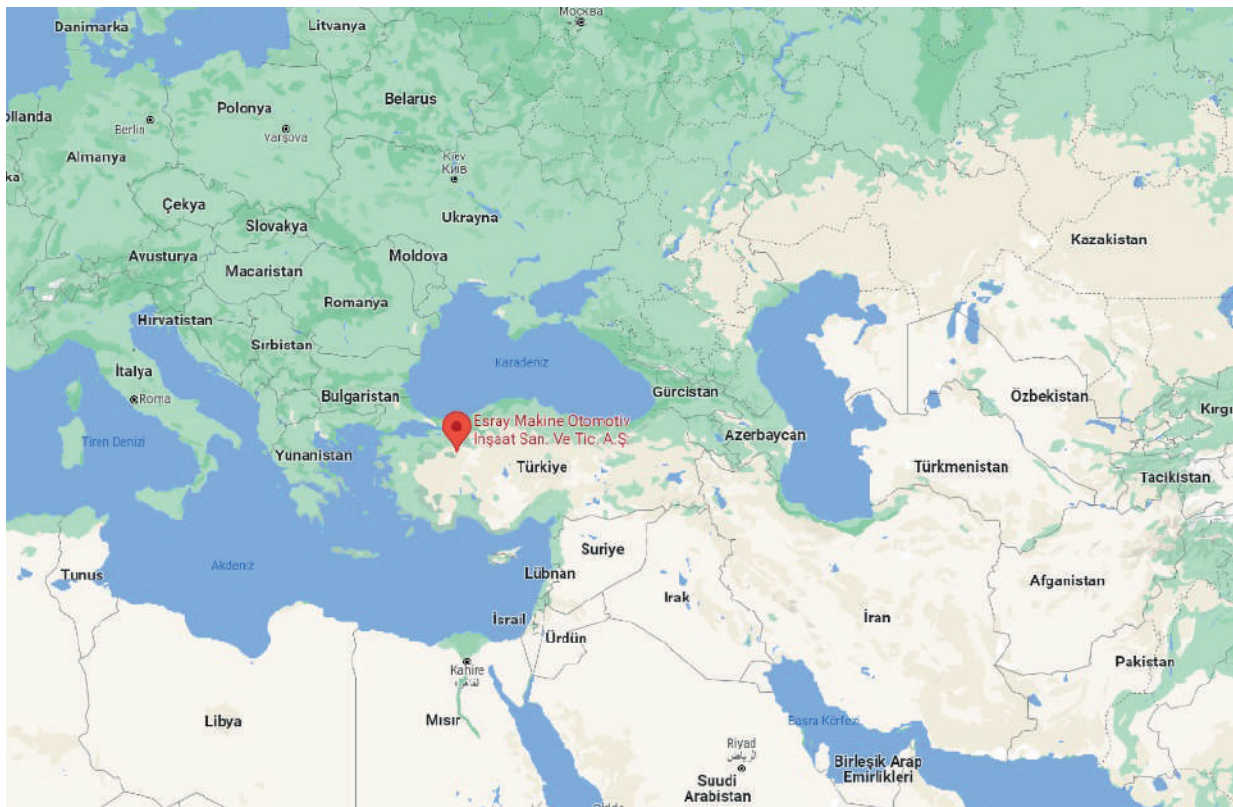



**23M FULLY AUTOMATED
UNDERFRAME SANDBLASTING
MACHINE**





You can download the digital catalog ▶



Esray Makina Otomotiv İnşaat San. ve Tic. A.Ş.

+90 222 236 26 00 - +90 222 236 26 04 (Fax)

+90 222 236 26 00

info@esray.com.tr

www.esray.com.tr

Organize Sanayi Bölgesi Orhan Erden Bulvarı No:9 Odunpazarı / Eskişehir / Türkiye

 /EsrayWagon

 @EsrayWagon

 EsrayWagon

 EsrayWagon